



# Swing Kingdom

MIGHTY PLAYSETS. SERIOUS FUN.



**COMMERCIAL  
PLAYGROUND EQUIPMENT**

# ABOUT OUR COMPANY

## BUILT FOR ADVENTURE



### Quality **In Every Detail** GUARANTEED

“With any company or product, errors can happen in manufacturing or workmanship.

We have been thankful for not only the impressive 50-year warranty that Swing Kingdom provides our customers, but also the fact that there are real people behind this warranty, who actually care about their product and customers, and making sure they are taken care of.”

- Kyle M Wenger, General Manager

Amish Direct Playgrounds LLC, New Holland, Pa.

### DOWNLOAD Swing Kingdom Design Center



# WHY CHOOSE US?

## STRONG, SAFE, DURABLE

Swing Kingdom's playgrounds are engineered from a safety first perspective. Our slip resistant, vinyl clad construction materials are always splinter free, and no wood means no harsh, annual chemical treatments. Stainless steel hardware and corner brackets bring added stability, while optional bars and rails allow for age appropriate customization.

Childhood is a time for lively imaginations and spirited adventures. It is also the time to build a strong foundation for active and healthy lifestyles. Swing Kingdom playgrounds combine the fun of childhood with the fulfillment of physical and developmental needs to deliver learning through play. The healthy habits that are fostered by enjoyable exercise may be the one thing more durable than our playgrounds.



## TABLE OF CONTENTS:

- An Amazing Tool For All Ages**  
The value of our online design tool ..... 4-5
- Top Three Things To Keep In Mind**  
When planning and picking the right  
playground for your community  
or establishment ..... 6-7
- Commercial Playground Equipment**  
The Best Value In Play ..... 8-9
- Fun Quest, Turtle Hideaway  
and Rocket Launcher ..... 10-11
- Preventing Playground Injuries**  
Why Is This Important ? ..... 12
- Protective Surface Materials** ..... 13
- Take a Look Inside:**  
Environmentally Friendly Playgrounds ..... 14
- Not Just Playing Structures** ..... 16-17
- Turbo Trek, Mission Possible  
and Turbo Jungle ..... 18-19
- The Benefits of Playing Outside**..... 20
- Kingdom Adventure, Play-a-neer Palace and  
Tunnel Adventure ..... 22-23
- Invest in the Best** ..... 24
- Swing Frame Options ..... 26
- SK Ark ..... 27
- Discovery Island and Dream Center ..... 29
- Warranty Information** ..... 30

# AN AMAZING TOOL FOR **ALL AGES**

## THE VALUE OF OUR ONLINE DESIGN TOOL

**A**s you've been shopping for a new playground or swing set, how many times have you had this thought, "This one is almost perfect. I just wish we could add a [fill in the blank]." There are many playground models to choose from but when you can't seem to find the one that checks all your boxes, it might be time to take matters into your own hands. Using our online design center, you can build a custom playground that includes every component on your wish list.

### GET STARTED WITH THE ONLINE DESIGN CENTER:

You can access the Design Center on our website or in our mobile app.



## ON OUR MOBILE APP:

You can start a custom playground design from scratch by clicking the red balloon on the screen. When you do, you will be prompted to choose a new playground base.

**For your mobile device, here is how to start:**

- 1: Download the app today.**
- 2: Use the balloons to add, remove or change products, dream, create and define your playground.**
- 3: Send your unique design to our builders.**
- 4: We will make your playground a reality, bring it to your location and set it up.**
- 5: Start PLAYING!**

## ON OUR WEBSITE:

When you first visit our Design Center page, it will populate with a pre-built playground that you can immediately begin to modify by clicking any of the balloons. See detailed instructions to the right.

# DETAILED APP INSTRUCTIONS



## STEP 1

You can start a custom playground design from scratch by clicking the red balloon on the screen. When you do, you will be prompted to choose a new playground base.



## STEP 2

From there, you can begin adding on different components. Click a colored balloon to add a new feature:

- Black = Entry and exit elements (ramps, ladders, slides, poles), as well as swing beams
- Purple = Swing types and options
- Red = Playground accessories
- Blue = Roof options

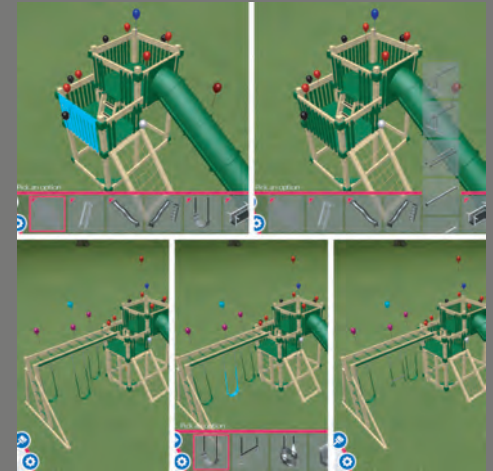

## STEP 3

### Want to Try Different Options?

Just click the balloon and replace the current element with something new. Take out a slide and add a rock climbing wall or remove a baby swing and add a trapeze. There are so many options to try!



## STEP 4

### Choose Your Colors

As you build a custom playground in the Design Center, you have the option to try out different color palettes as well. Click on the paint brush icon at any time, and watch your design change colors right before your eyes.

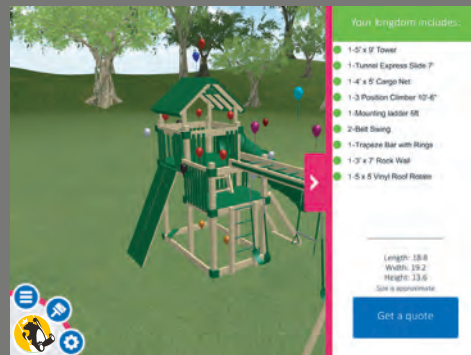

## STEP 5

### When Your Custom Design is Complete

At any point as you design your custom playground, you can click on the white arrow on the right side of your screen to see a running list of all the playground elements that your design includes. When you've landed on the perfect custom design, click on "Get a Quote," and you can email your design to a Swing Kingdom Dealer. You can also print a copy of your design inventory to share when you visit one of our dealers in person.

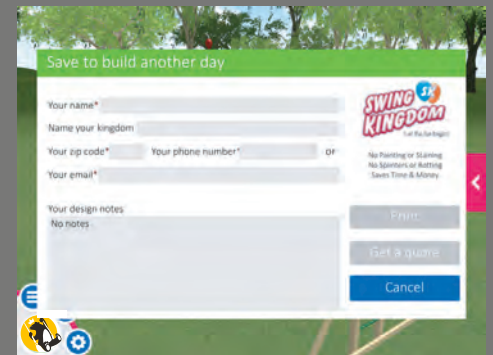

# SAVE AND SHARE YOUR DESIGN!



# MIGHTY PLAYSETS. SERIOUS FUN.

*"This (playground) is better than I could imagine.  
They play hide and seek."*

**- Diana Hurst, Principal**  
*Linville Hill Christian School, Paradise, PA*

*"We don't get blisters or splinters because it's not wood."*  
**- LeBron, age 8**

*"It's almost like real rock climbing"*  
**- Staryln, age 8**

*"The monkey bars don't hurt my hands anymore"*  
**- Elijah, age 8**

*"We love the swirly slides."*  
**- Ana, age 6**





## TOP THREE THINGS TO KEEP IN MIND

When planning and picking the right playground for your community or establishment

*Purchasing a commercial playground is a big investment. The members of your community, school, or church have dedicated their time and resources to raise the funds necessary for such a large purchase. In return, you want to make sure the playground you choose is a quality product that is built to last while serving the needs of all your members, young and old. Here are several tips that you should consider when choosing a commercial playground as the focal point of a fun, outdoor play area.*

### **Commercial Playground Tip #1:** Opportunity for All Ages and Abilities

Playground components offer ways for young children to become more steady on their feet while they practice balance and motor skills, and for older children to build strength, flexibility, and endurance. Outdoor play is also essential for developing their critical thinking, problem-solving, and social skills. So, it's important that your commercial playground is built with activities and accessories that are appropriate for all age groups.

### **For children ages 5 and younger:**

- Platforms of various heights: no higher than 3 ft (up to age 2) or 6 ft (ages 2-5)
- Open slides
- Short ramps with rock climbing grips
- Bucket swings and horse rider swings

### **For children ages 5 and older:**

- No equipment should be higher than 8 ft
- Turbo and tunnel slides
- Large rock climbing ramps
- Cargo nets or ropes
- Trapeze bars, horizontal ladders, and fireman's poles

When choosing a commercial playground, it's also necessary that it be compliant with the Americans with Disabilities Act (ADA) and accessible for children who are living with disabilities. Included in the accessibility guidelines are the need for ground-level play components, as well as accessible routes to each type of component. You can read more in the Accessibility Guideline for Play Areas document, created by the United States Access Board.

### **Commercial Playground Tip #2:** Safety Standards

When you're plotting out the location for the new playground on your organization's property, you need to pay special attention to what is referred to as the use zone. You see dimensions that show a playground as 31' by 22' and think, "Yes, we've got space for that!" But a quality, reputable playground manufacturer or dealer will also provide requirements for use zones. This extra square footage is a necessary safety precaution to ensure that children on swings don't collide with a tree or that children winding down the slide aren't carried by their momentum into a surrounding

fence. It also provides a wide space for children to walk around the play structure without getting kicked or injured by those using the equipment. Do you remember the playgrounds of your youth, that were constructed on top of blacktop surfaces? Considering that most playground injuries result from falls from the equipment, this wasn't the safest solution. It's now recommended that your play area is set upon a shock-absorbing surface, such as rubber mulch, rubber mats, wood chips, or sand. This will lessen the impact if a child falls onto the surface. For additional information on purchasing a playground that will keep the children in your community safe from injuries, read our interview with Phi Viet Le, Certified Playground Safety Inspector. He discusses more playground safety standards of which you should be aware.

### **Commercial Playground Tip #3:** Maintenance

When choosing a commercial playground, you'll have options that are constructed of vinyl, wood, or metal. While they all have advantages, for example, metal playgrounds are the most cost-effective option and wooden playgrounds offer a natural look. If your priority is ensuring that your playground remains durable and attractive for years, vinyl is a better choice.

Metal playgrounds can be victim to rusting and chipped powder coating. Wooden playgrounds will need to be stained or painted periodically, as well as sanded down if excessive splintering occurs. With vinyl construction, your playground will maintain its attractiveness with a quick power washing each year. Less time for maintenance means more time for fun!

# COMMERCIAL PLAYGROUND EQUIPMENT

THE BEST VALUE IN PLAY

---

Swing Kingdom designs and builds the strongest vinyl clad playgrounds on the market. As the largest vinyl clad playground manufacturer in the United States, we have a proven reputation for premium craftsmanship.

For well over a decade, Swing Kingdom has been equipping commercial facilities with more than just swings and slides. Our safe and durable playgrounds launch active imaginations from a solid platform of maintenance free construction. As a family owned company, Swing Kingdom recognizes that everyone is unique. That is why, from rock walls to turbo twister slides, and telescopes to sandboxes, we offer accessories to match your distinct requirements.

Our network of authorized dealers have been individually selected to deliver upon Swing Kingdom's high standard of honest, and straight-forward customer service. Our authorized dealer representatives will work with you to design a playground that meets your needs. Then, your playground will be assembled, on site, by a trained Swing Kingdom installation team.







*"Every playset is made-to-order, so you are not paying a customization fee. You can truly make your own playset unique to your needs and budget. Safety is of utmost concern with every customized playset. The experts at Swing Kingdom are always looking out for your children's well-being."*

*- Tom Rosenecker  
American Eagle Fireplace & Playsets*

# Fun Quest

Ages: 2-5 Years | Child Capacity: 9-15



**Overall Dimensions:** 28.5'w x 15.1'd x 8'h

**Weight:** 3,612 lbs

**Color:** White PVC, Green Accents

**Towers:** 5' x 5', 5' x 9'

**Deck Height:** 3'

**Access:** (2) ADA Transfer Stations

**Climber:** 3' x 3' Rock Wall

**Connectors:** 8' Bridge with Railing, Crawl Tunnel

**Slide:** 3' Dual Slide

**Fun Items:** ABC Activity Panel, Clock Activity Panel, Bubble Panel



**Space Needed:**  
41' Wide x 34' Deep

Standard Color Options:



Almond and Green



Almond, Yellow and Red



White and Green



White and Blue



White and Gray

Premium Color Options:



Wood Grain  
and Green



Wood Grain  
and Red



# Turtle Hideaway

Ages: 5-12 Years | Child Capacity: 9-15



**Space Needed:**  
43' Wide x 34' Deep

**Overall Dimensions:** 22'w x 27'd x 12'h  
**Weight:** 3,270 lbs  
**Color:** Almond PVC, Red and Yellow Accents  
**Tower:** 5' x 5'  
**Deck Height:** 5'  
**Access:** ADA Transfer Station, Tower Mounting Ladder  
**Roof:** 5' x 5' Vinyl  
**Climber:** NOC Climber 5'

**Slides:** (2) 3' Sidewinder Slides, 5' Angle Slide, 10' Avalanche Slide  
**Fun Items:** (2) Bubble Panels  
**Items:** 5' x 5' Clubhouse Decking, (2) 5' x 5' Clubhouse Walls with Window  
**Anchors:** (2)

**Standard Color Options:**



**Premium Color Options:**



# Rocket Launcher

Ages: 2-5 Years | Child Capacity: 9-15



**Space Needed:**  
43' Wide x 34' Deep

**Overall Dimensions:** 18'w x 19'd x 11'h  
**Weight:** 1,912 lbs.  
**Color:** Almond PVC, Red and Yellow Accents  
**Tower:** 5' X 9' Tower  
**Deck Heights:** 3', 5'  
**Access:** ADA Transfer Station  
**Roof:** Gable Roof  
**Climber:** 5' Rock Wall w/ Rope

**Slides:** (2) 10' Avalanche Slides, 3' Tunnel Express Slide  
**Fun Items:** Ship's Wheel, Telescope, Binoculars, Bubble Panel, Tic-Tac-Toe Panel  
**Anchors:** 4

**Standard Color Options:**



**Premium Color Options:**



# PREVENTING PLAYGROUND INJURIES

## Why is this important ?

---

Playgrounds are the perfect place for children to explore and let their imaginations run wild. Feeling the fresh breeze as they swing or slide through the air is truly euphoric. One thing that can ruin their fun is an unexpected bump or fall serious enough for a hospital visit.

Unfortunately, these types of trips occur more often than they should. Each year, thousands of children are admitted to the emergency room for injuries that happened on playground equipment. Preventing playground injuries is easier than you may think. Read on to find out how you can promote safer play while your children enjoy time outside.

### Potential Injuries and Risks Are No Laughing Matter

Playgrounds have platforms that can stand as high as 5' to 7' above the ground, increasing children's chances of incurring an injury from a fall. In fact, injuries are most common when playing on climbers, swings, and slides, and close to 70 percent of all playground injuries are related to children falling to the ground.

Children between the ages of five and twelve suffer the most injuries on the playground. The most common playground-related injuries include:

- broken bones
- black eyes
- bruises
- head injuries
- cuts
- dislocations
- bloody noses
- contusions
- knocked out teeth
- sprains

### Quick Tips For Safer Play

Children should be playing on age-appropriate equipment, so make sure that your equipment is appropriate for the age groups using your playground. Playgrounds are generally designed for various age groups. Children ages two to five should be playing on equipment that offers lower platforms, shorter ladders, and shorter ramps. Additionally, slides that are 4' in height are ideal for children this age.

Swings are not one-size-fits-all. There are swing options that perfectly fit the needs of children as they grow and develop. Babies with a good amount of head control and those who can sit up with support are able to use an infant swing (bucket-shaped). Babies (usually younger than nine months), who are unable to control their head or sit with support, should be swinging in a baby swing with harness straps and full back support.

Check openings on the entire playground. Examine all openings on the equipment. To avoid your child's head getting stuck, the spaces should be smaller than 3.5" or larger than 9" in length and width. Elevated platforms or ramps should have guardrails and barriers to prevent falls.

Make sure appropriate fall surfacing is being used. Avoid playing on playground equipment that is over concrete, asphalt, blacktop, or grass. Alternatively, playground equipment should be over wood chips, rubber mulch, or sand. Rubber safety pads that are strategically placed in areas where there is a lot of landing/impact is ideal.

### How You Can Play a Role In Preventing Playground Injuries

The National Program for Playground Safety (NPPS) has been around for over ten years and works to help communities across the United States pay closer attention to critical issues relating to playground safety. Playgrounds that promote safe play are in tune with the S.A.F.E. Factors:

- Proper supervision of children while playing on playground equipment is crucial to their safety.
- Age-appropriate playgrounds that offer safe play spaces for children big and small are ideal.
- Appropriate fall surfacing under and around playgrounds helps to lessen the impact of a bad fall.
- Proper, routine maintenance of playground equipment helps to ensure children have a safe place to play.

Any organization that has a playground on their property can take the first step to safety by utilizing a Safety Report Card, created by NPPS to ensure their outdoor play space is safe for children. The next step would be to schedule an official inspection done by a Certified Playground Safety Inspector.

# PLAYGROUND SURFACING

## Rubber Mulch



*One ton of Rubber Mulch covers 250 square feet at 3" depth.*

Swing Kingdom rubber mulch is a uniquely processed rubber granule designed specifically to protect children from falls on playgrounds. Over 200,000 playground injuries result in emergency room visits each year!

Children falling during play is inevitable; Getting seriously hurt doesn't have to be. Swing Kingdom Rubber Mulch surfaces have been proven to significantly decrease the incidence of fall-related playground injuries. In fact, Swing Kingdom Rubber Mulch provides the highest safety rating of any playground surface.

Since Swing Kingdom Rubber Mulch requires minimal maintenance, dries quickly after rain, and will not freeze, compact, or decompose, you can be assured that it is the most cost-effective playground surface available.

Swing Kingdom Rubber Mulch meets the latest CPSC safety guidelines, ASTM F-1951, and ASTM F-1292. Swing Kingdom Rubber Mulch is safe, fun and economical, and is so well manufactured that it's guaranteed to last a lifetime!

## Turf



Our playground turf is designed from the ground up for safety. It's fully certified by the International Play Equipment Manufacturer's Association (IPEMA). Combined with foam padding underlayment and infill, our system is the safest turf play surface available today.

## Pour in Place Rubber



Rubber surfacing with Swing Kingdom combines high tech polymer resins with rubber to create a resilient, non-skid surface that is virtually indestructible. Swing Kingdom rubber surfacing is professionally installed over your new or existing surface. It is available in many different colors.

# TAKE A LOOK INSIDE

## ***ENVIRONMENTALLY FRIENDLY PLAYGROUNDS***

Being good environmental stewards is something that Swing Kingdom commits to wholeheartedly, which is why we consider it our responsibility to take care of the world around us. Wherever possible, we use high-quality, recycled materials as part of our manufacturing process to produce environmentally friendly playgrounds.

### **Used Plastic Containers Become Playground Fun**

Using recycled plastic materials to create something new that can be used for years to come is the norm for some manufacturers. Utilizing empty plastic milk jugs to form posts and decks for building playground equipment is a unique approach to helping the environment.

How can plastic containers be used to create vital structural components for playgrounds?

**Step 1:** Milk jugs are cleaned, flattened, and placed into shredding machines that chip the plastic into small pieces.

**Step 2:** A heating process is used to bond together the plastic material and a coloring agent, adding color without using paint.

**Step 3:** A machine is used for making recycled posts for playground equipment. This machine ejects the recycled plastic into various post sizes, that are then cut to length.

Did you know that recycling your plastic milk jugs helps immensely? A small bench uses close to 500 milk jugs and a larger playground can use more than 70,000 milk jugs. Therefore, your recycling efforts, great or small, contribute to the creation of sustainable materials.

Playgrounds that are made of recycled plastic do not rust, peel, or produce splinters. Not only that, but the use of recycled materials saves landfill space, so it's a win-win situation for everyone.

### **Sustainability of Wood Components**

Swing Kingdom's play structures are made of Wolmanized®, natural select, outdoor wood that is encased in vinyl to provide a durable, low-maintenance structure for commercial use.

Wolmanized® Wood has multiple environmental benefits:

- Requires less energy to preserve than alternative building products.
- The production releases no air pollutants and no wastewater.
- The treatment extends the service life of the wood, significantly reducing the demands on forests.
- When used as recommended, Wolmanized® wood is harmless to people, plants, and animals.





# NOT JUST PLAY STRUCTURES

*Swing Kingdom is an establishment that is more than just playground equipment. We understand that when an organization puts in a play area, it means so much more to them and their community. This is an area that provides opportunities for fellowship, friendship, and developmental growth for all ages.*

*That is why Swing Kingdom has developed site amenities to create an atmosphere that is inviting, clean, and relaxing. Our amenities are made to complement your Swing Kingdom playground in a way that will not only give them a welcoming feeling when arriving but a reason to stay longer.*

*You can find some of what we offer on the back of this buyer's guide, but you can also reach out to your local Swing Kingdom dealer for more information about any of our products or services.*

## **Benches**



Looking for a modern bench that is made to enhance the overall appearance of your playground? Swing Kingdom has an exclusive bench line that is not only good to look at but is amazingly comfortable for all ages to rest.

## **Trash Cans**



Keep your playground clean and neat by offering a place for users to dispose of their trash properly. Swing Kingdom offers a couple of different options that allow you to do just that.





### Signage or Custom Signs



Whether you need a custom dedication sign or a playground rules sign, we here at Swing Kingdom have the ability to get that task accomplished in house.

### Tables

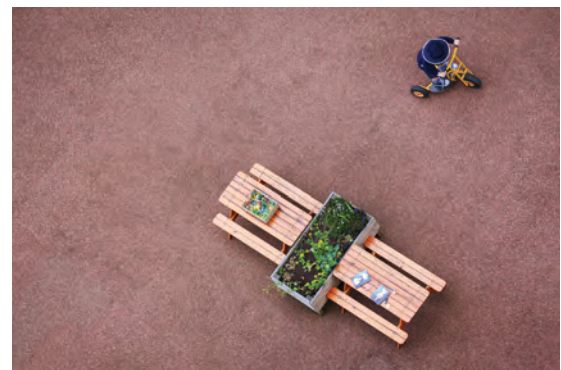

Give your community a place to enjoy a relaxing sunny afternoon lunch at your playground with their family. You can do so by offering Swing Kingdom vinyl or metal picnic tables.

# Turbo Trek

Ages: 5-12 Years | Child Capacity: 20-32



**Overall Dimensions:** 31'w x 21'd x 13'h

**Weight:** 4,905 lbs

**Color:** White PVC, Blue Accents

**Tower 1:** 5' x 9'

**Deck Heights:** 5', 7'

**Roof:** 5' x 5' Vinyl

**Tower 2:** 5' x 9'

**Deck Heights:** 3', 5'

**Roof:** 5' x 9' Double Vinyl

**Access:** ADA Transfer Station, Flat Step Access Ladder with Access Railing, 12' Ramp with Rails

**Climber:** 3' Rock Wall, 6' ADA Monkey Bar

**Connector:** 8' Bridge with Railing

**Slides:** 7' Sidewinder Slide, 7' Turbo Twister Slide, 5' Turbo Twister Slide, 10' Avalanche Slide, 3' Tunnel Express Slide

**Fun Items:** Fire Pole 7', Bubble Panel



**Space Needed:**  
28' Wide x 32' Deep

Standard Color Options:



Almond and Green



Almond, Yellow and Red



White and Green



White and Blue



White and Gray

Premium Color Options:



Wood Grain and Green



Wood Grain and Red

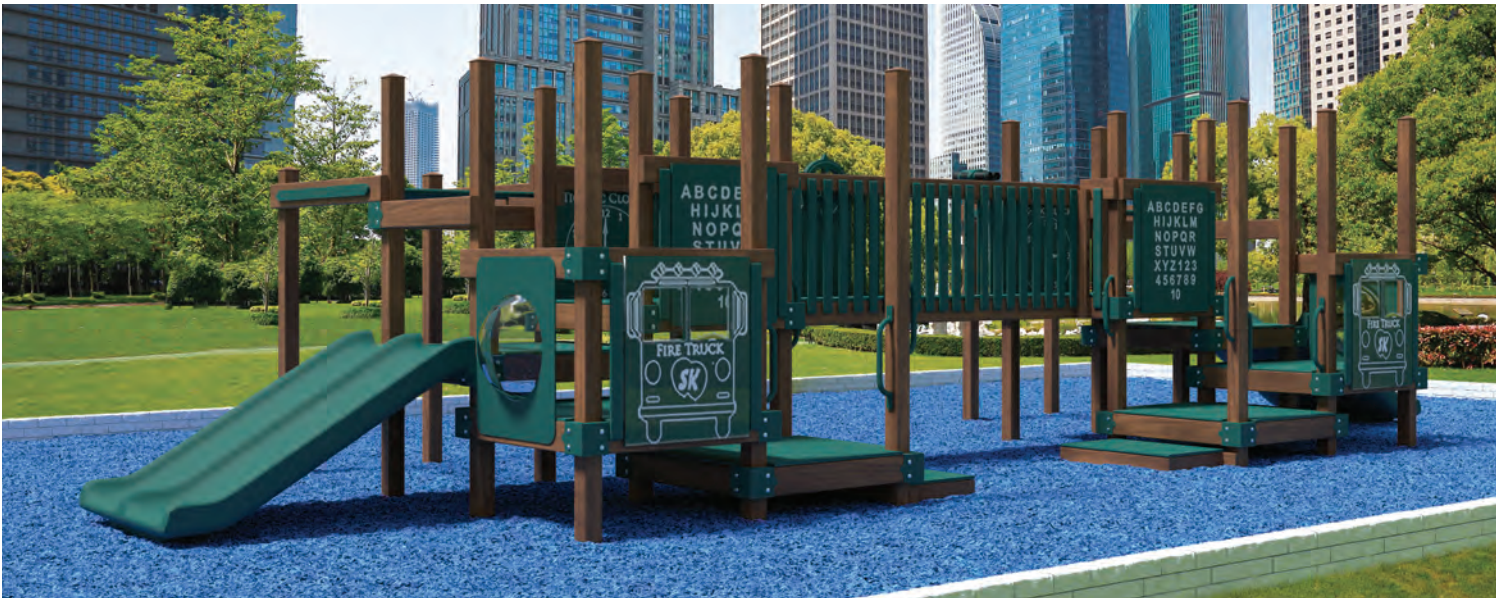

## Mission Possible

Ages: 2-5 Years | Child Capacity: 20-32



**Space Needed:**  
34' Wide x 34' Deep

**Overall Dimensions:** 35'w x 12'd x 8'h

**Weight:** 3,306 lbs

**Color:** Premium Wood Grain, Green Accents

**Towers:** (2) ADA Spiral Stair

**Deck Heights:** 7", 13 3/4", 21 1/4", 28 3/4", 36 1/4"

**Climbers:** (2) 6' Monkey Bar

**Connector:** 8' Bridge with Railing

**Slides:** (2) 3' Dual Slide, 10' Avalanche Slide

**Fun Items:** (2) Bubble Panels, (2) Fire Truck Activity Panels, (2) Clock Activity Panels, (2) ABC Activity Panels, Binoculars

**Standard Color Options:**



Almond and Green



Almond, Yellow and Red



White and Green



White and Blue



White and Gray

**Premium Color Options:**



Wood Grain  
and Green



Wood Grain  
and Red



## Turbo Jungle

Ages: 2-5 Years | Child Capacity: 20-32



**Space Needed:**  
38' Wide x 38' Deep

**Overall Dimensions:** 32'w x 31'd x 14'h

**Weight:** 2,122 lbs

**Color:** White PVC, Blue Accents

**Tower:** 5' x 5' Deck

**Deck Height:** 5'

**Roof:** Gable

**Slides:** 10' Avalanche Slide, 5' Sidewinder Slide,  
(2) 5' Angle Tunnel Express Slides

**Connector:** 6'-6" Bridge with Rails

**Tower:** 5' x 9' Tower

**Deck Heights:** 3', 4'

**Access:** ADA Transfer Station

**Roof:** Gable

**Climbers:** 3' Rock Wall

**Slide:** 5' Sidewinder Slide

**Fun Items:** Ship's Wheel, Bubble Panel

**Standard Color Options:**



Almond and Green



Almond, Yellow and Red



White and Green



White and Blue



White and Gray

**Premium Color Options:**



Wood Grain  
and Green



Wood Grain  
and Red

# THE BENEFITS OF PLAYING OUTSIDE

---

The importance of spending time outdoors and being physically active is more important for our children than it has ever been before. The #1 health concern that parents have for their children today is childhood obesity. According to the American Heart Association, one in three children is overweight or obese, a statistic that has tripled since 1971.

A contributor to obesity and one of the main reasons that children spend less time on physical activity is the rapidly growing trend of "screen time". Young children can spend as much as 5-7 hours a day watching TV, playing video games, using the internet, or texting/chatting with friends online. Of course, being physically active is important for building strong, healthy bodies, but there are other physical and mental benefits to playing outside regularly that you may not realize.

## Physical Benefits of Playing Outside

- Helps in developing large and small motor skills
- Builds cardiovascular endurance
- Fresh air slows the spread of infections, which is especially important during the cold and flu season
- Improves sleep as outdoor light helps to set your internal clock, which leads to better sleep at night
- Improves distance vision and lowers chances of being nearsighted
- Increases exposure to sunlight and vitamin D, which can help prevent bone issues, heart disease, or diabetes

## Mental Benefits of Playing Outside

- Allows children to recharge and release pent-up energy after long periods of learning, making for better academic progress
- Reduces symptoms of inattentiveness or hyperactivity, keeping children alert
- Stress levels fall and good moods increase when children are exposed to green space
- Enhances social interaction and helps children develop relationships

The National Wildlife Federation outlines all the ways that outside play benefits children, both physically and mentally.





# Kingdom Adventure

Ages: 5-12 Years | Child Capacity: 32-40

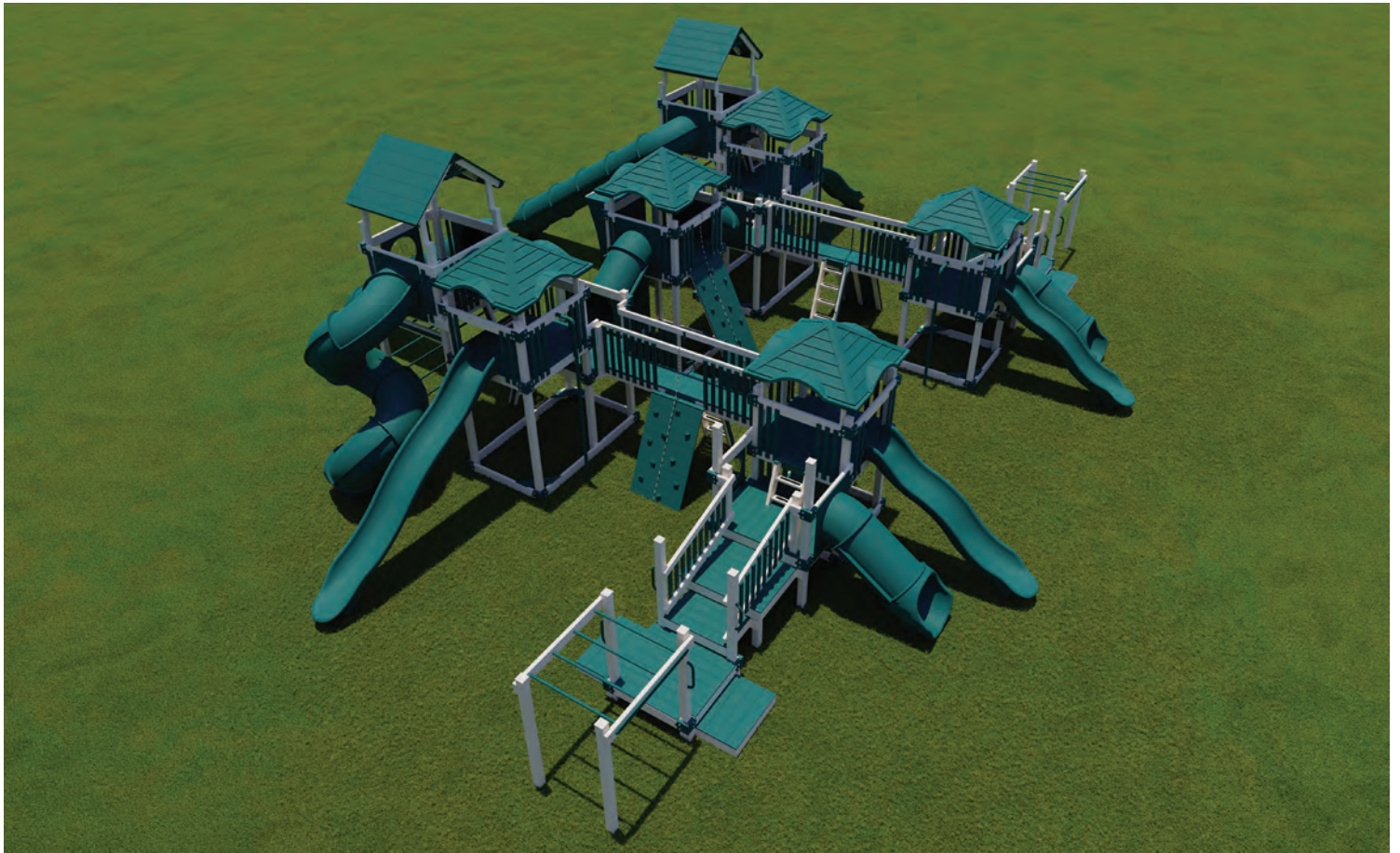

**Overall Dimensions:** 54'w x 44'd x 16'h

**Weight:** 12,095 lbs

**Color:** Almond PVC, Green Accents

**Tower 1:** 5' x 5'

**Deck Height:** 5'

**Access:** ADA Transfer Station, Flat Step Access, Ladder with Access Railing

**Roof:** 5' x 5' Pyramid

**Climbers:** Fire Pole 5', ADA Monkey Bars 6', 3' x 5' Rock Wall

**Slides:** 3' Tunnel Express Slide, 10' Avalanche Slide

**Fun Item:** Bubble Panel

**Connector:** 8' Bridge with Railing

**Tower 2:** 5' x 9', Jungle Bar Tower

**Deck Heights:** 5', 7', 9'

**Access:** Flat Step Access Ladder with Access Railing

**Roof:** 5' x 5' Pyramid

**Climber:** Fire Pole 7'

**Slides:** 9' Sidewinder Slide, 9' Turbo Twister Slide, 14' Avalanche Slide

**Fun Item:** Bubble Panel

**Connector:** Slope Tower Tunnel

**Tower 3:** 5' x 5'

**Deck Height:** 5'

**Roof:** 5' x 5' Pyramid

**Climbers:** 3' x 7' Rock Wall, Warp Wall 10'

**Tower 4:** 5' x 9', Jungle Bar Tower

**Deck Heights:** 5', 7', 9'

**Access:** Flat Step Access Ladder with Access Railing

**Roof:** 5' x 5' Pyramid

**Climber:** 7' Fire Pole

**Slides:** 9' Sidewinder Slide, 9' Turbo Twister Slide, 14' Avalanche Slide

**Fun Item:** Bubble Panel

**Connector:** Slope Tower Tunnel

**Tower 5:** 5' x 5'

**Deck Height:** 5'

**Access:** ADA Transfer Station

**Roof:** 5' x 5' Pyramid

**Climbers:** 5' Fire Pole, 6' ADA Monkey Bars

**Slides:** 3' Tunnel Express Slide, 10' Avalanche Slide

**Fun Item:** Bubble Panel

**Connectors:** 8' Bridge with Railing, Flat Step Access Ladder with Access Railing, 3' x 5' Rock Wall



**Space Needed:**  
60' Wide x 56' Deep

Standard Color Options:



Almond and Green



Almond, Yellow and Red



White and Green



White and Blue



White and Gray

Premium Color Options:



Wood Grain  
and Green



Wood Grain  
and Red



## Kingdom Palace

Ages: 2-5 Years | Child Capacity: 32-40



**Space Needed:**  
54' Wide x 42' Deep

**Overall Dimensions:** 43' w x 30' d x 12' h

**Weight:** 9,810 lbs

**Color:** White PVC, Blue Accents

**Towers:** (4) 5' x 5' Deck

**Deck Height:** 5'

**Access:** (2) ADA Transfer Stations,  
Flat Step Access Ladder with Access Railing,  
(2) 12' Ramps with Rails

**Roofs:** (2) Gable

**Slides:** (3) 10' Avalanche Slide,  
10' Waterfall Slide

**Fun Items:** ABC Activity Panel,  
Tic Tac Toe

**Optional:** 5' x 5' Clubhouse Decking

Standard Color Options:



Premium Color Options:



## Tunnel Adventure

Ages: 2-5 Years | Child Capacity: 20-31



**Space Needed:**  
37' Wide x 40' Deep

**Overall Dimensions:** 31' w x 34' d x 12' h

**Weight:** 2,312 lbs

**Color:** White PVC, Blue Accents

**Tower 1:** 5' x 5'

**Deck Height:** 3'

**Access:** 3' x 8' Ramp with Rails

**Roof:** 5' x 5' Vinyl

**Slides:** 3' Dual Slide

**Fun Items:** Bubble Panel, Ship's Wheel, Telescope

**Connector:** Slope Tower Tunnel

**Tower 2:** 5' x 5'

**Deck Height:** 5'

**Access:** Flat Step Access Ladder with Access Railing

**Roof:** 5' x 5' Vinyl Roof

**Slides:** (2) 10' Avalanche Slide

**Fun Items:** Telescope, Ship's Wheel

**Connector:** Slope Tower Tunnel

**Tower 3:** 5' x 5'

**Deck Height:** 3'

**Roof:** 5' x 5' Vinyl

**Connector:** S-Shape Tower Tunnel

**Fun Items:** Clock Activity Panel, Tic Tac Toe,  
Telescope, Ship's Wheel

**Tower 4:** 5' x 5'

**Deck Height:** 3'

**Access:** ADA Transfer Station

**Roof:** 5' x 5' Vinyl Roof

**Slides:** (2) 3' Sidewinder

**Fun Items:** Bubble Panel, Tic Tac Toe, Binoculars,  
Telescope, Ship's Wheel

Standard Color Options:

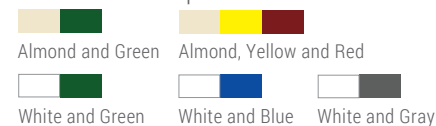

Premium Color Options:



# INVEST WITH **THE BEST**

By Eric G. Stark

Diana Hurst's first interaction with Swing Kingdom had nothing to do with buying a playground. Hurst, the principal at Linville Hill Christian School in Paradise, Pa., was teaching a math class a few years ago and reached out to Swing Kingdom for help.

She had her middle school class working on an online plan for a playground, their dream play area. Students came up with the measurements and dimensions to work with. She wanted the children to have something tangible for practice, so she randomly called Swing Kingdom and asked for some catalogs. They gave her 20 catalogs, one for each student. "Swing Kingdom really showed support for education," Hurst said. Fast forward to this year and the principal got to see Swing Kingdom's quality playgrounds first hand.

Linville Hill, a kindergarten through sixth grade school, wanted a new playground. They started a fundraiser to raise money called "Value of Play" and raised the money for the playground in 20 minutes. Children in kindergarten through second grade (about 50 kids) use the playground. Hurst said the older children requested time to play on it also. The features include a slide and tube slide, a ladder, a rock climbing wall, and monkey bars (kids love the monkey bars). The new playground went up in fall of 2018 and the first people to play on it were Amish children who lived near the school. The teachers played on it next, and eventually, the children at Linville Hill had their turn. "It is better than I could imagine," Hurst said. "The kids play hide and seek. It has been enjoyable."

She said the children had to spread the mulch under the playground before they played on the set. The small children dumped buckets of wood chips. Then it was play time. "We are a private school and usually we get leftovers," Hurst said. "With this playground it is not used. It is brand new and it is gorgeous."







### Swing Frame Options:

#### Standard Color Options:



Almond and Green



Almond, Yellow and Red



White and Green



White and Blue



White and Gray



Basic Tower with  
ADA Transfer Station



ADA Transfer Station



Metal Frame for Swings



### Hard Seat Swing:

For a soft and durable, modern swing, pick up our newest single rider flat swing seat. It is designed to give your playground a modern, new look, while providing the best and most fun ride for the user.



### Baby Swing:

Provide the best baby swing on the market for your playground. This is designed to give a child from 9 months up to 3 years of age the most comfortable seat for swinging. With the high back for support, it will have your child swinging for hours.

# SK Ark

Ages: 5-12 Years | Child Capacity: 20-32



**Overall Dimensions:** 26'w x 22'd x 16'h

**Weight:** 6,500 lbs.

**Color:** Clay, Red, and Yellow Accents

**Deck Heights:** 5', 7'

**Access:** 12' Ramp w/ Rope

**Slides:** 14' Avalanche Slide, 10' Waterfall Slide

**Fun Items:** Ship's Wheel, Spotlight, (2) Telescopes,  
Megaphone, Binoculars, Bubble Panel



**Space Needed:**

38' Wide x 32' Deep

**Standard Color Options:**  
As shown in the image above.



Clay, Yellow and Red





Dream Center  
Sold Separately

# Discovery Island

Ages: 2-5 Years | Child Capacity: 21-25

**Overall Dimensions:** 22'w x 14'd x 9'h  
**Weight:** 3,468 lbs  
**Color:** White PVC, Green Accents  
**Tower:** 5' x 5' Deck  
**Deck Height:** 3'  
**Access:** ADA Transfer Station

**Roof:** Gable  
**Climbers:** 6' ADA Monkey Bar, 3' x 3' Rock Wall  
**Slides:** 3' Sidewinder Slide, 3' Dual Slide  
**Fun Item:** (2) Ship's Wheel  
**Anchors:** 6

**Option:** Dream Center (Sold Separately)



**Space Needed:**  
35' Wide x 35' Deep

Standard Color Options:



Premium Color Options:



**Space Needed:**  
40' Deep x 37' Wide

# Dream Center

Ages: 2-5 Years | Child Capacity: 9-11

**Overall Dimensions:** 12'w x 17'd x 4'h  
**Weight:** 630 lbs  
**Color:** Almond PVC, Green Accents  
**Connector:** 6' 6" Tower Tunnel  
**Fun Items:** 2' x 5' Lemonade Stand with (2) stools, Tic Toc Clock, Bubble Panel



**Space Needed:**  
16' Wide x 25' Deep

Standard Color Options:

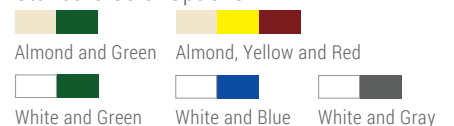

Premium Color Options:





# LIMITED LIFETIME 20 YEAR AND 5 YEAR WARRANTY

Subject to establishment use and proper installation by a certified SK installer. (SK units are built to meet CPSC guidelines and ASTM F1487 standards but have not been tested for the general public use.)

Swing Kingdom warrants to the original purchaser at the original installation address, that the structural components of the playground systems, such as the PVC plastic lumber and wood components are covered by a 20-year warranty. In addition, all canopies, slides, metal components, swings, and accessories are warranted for 5 years from date of original purchase.

Swing Kingdom's products are not warranted as being suitable for a particular purpose. The suitability of the product is for the purchaser to determine. This warranty does not cover normal wear and tear, failure to properly maintain the product, or damage resulting from misuse or abuse of the product, additionally any acts of nature such as lightning, storms, hurricanes, tornados, earthquakes or any extreme weather conditions. Also, any alteration, addition or relocation of the product will void this warranty.

Swing Kingdom reserves the right to examine photographs and/or physical evidence of the product claimed to be defective and to recover product prior to any warranty claim being approved. All products returned for inspection must be sent freight prepaid. In the event of a defect covered by these warranties, Swing Kingdom will remedy the defect within a reasonable time frame. The remedy will consist of repair or replacement of the defective piece unless it is not practical. In the event of an approved warranty claim, replacement parts are free of charge to the claimant. All freight costs for replacement parts are not covered under the warranty and are the responsibility of the original purchaser.

Adult supervision is recommended while enjoying your play system. For safety and comfort reasons, Swing Kingdom reserves the right to make design and construction changes without notice.

## MAINTENANCE FREE

# AERIAL VIEW MAPS

**FUN QUEST**

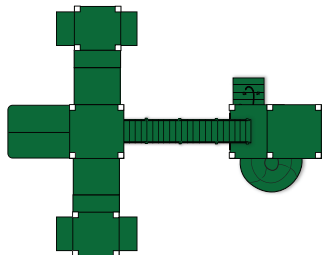

41W X 34D  
PAGE 10

**TURTLE HIDEAWAY**

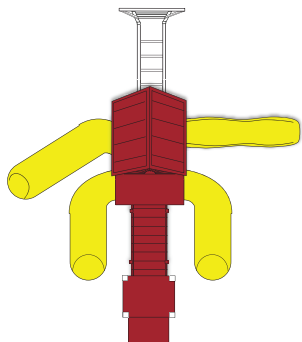

43W X 34D  
PAGE 11

**ROCKET LAUNCHER**

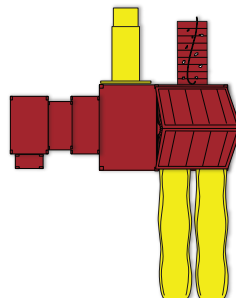

43W X 34D  
PAGE 11

**TURBO TREK**

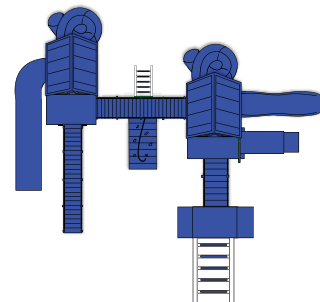

28W X 32D  
PAGE 18

**MISSION POSSIBLE**

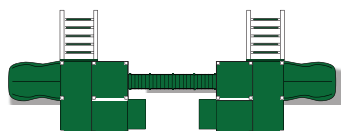

34W X 34D  
PAGE 19

**TURBO JUNGLE**

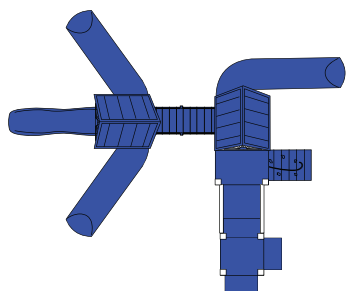

38W X 38D  
PAGE 19

**KINGDOM ADVENTURE**

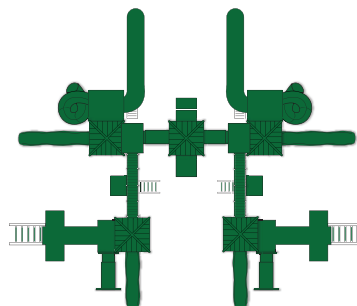

60W X 56D  
PAGE 22

**PLAY-A-NEER PALACE**

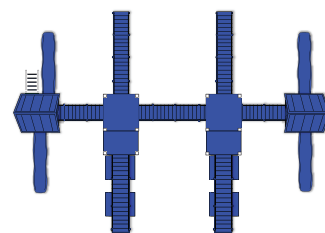

54W X 42D  
PAGE 23

**TUNNEL ADVENTURE**

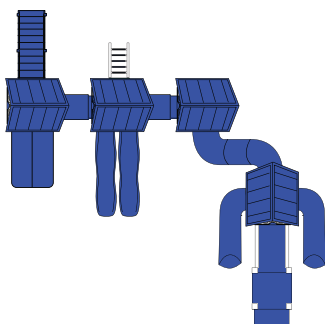

37W X 40D  
PAGE 23

**SK ARK**

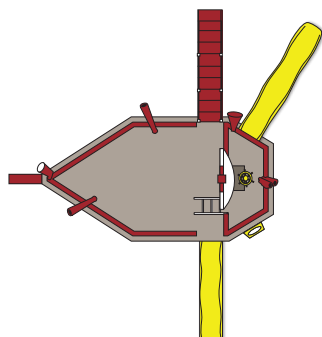

38W X 32D  
PAGE 27

**DISCOVERY ISLAND**

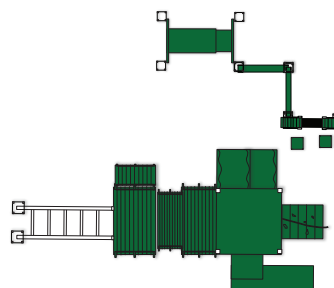

35W X 35D  
PAGE 29

**DREAM CENTER**

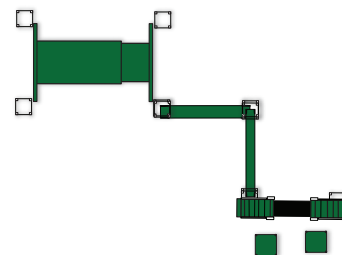

16W X 25D  
PAGE 29



# Swing Kingdom

©2022 Swing Kingdom, LLC. All rights reserved. No part of this catalog may be reproduced in any form without the prior expressed written authorization of Swing Kingdom, LLC.